

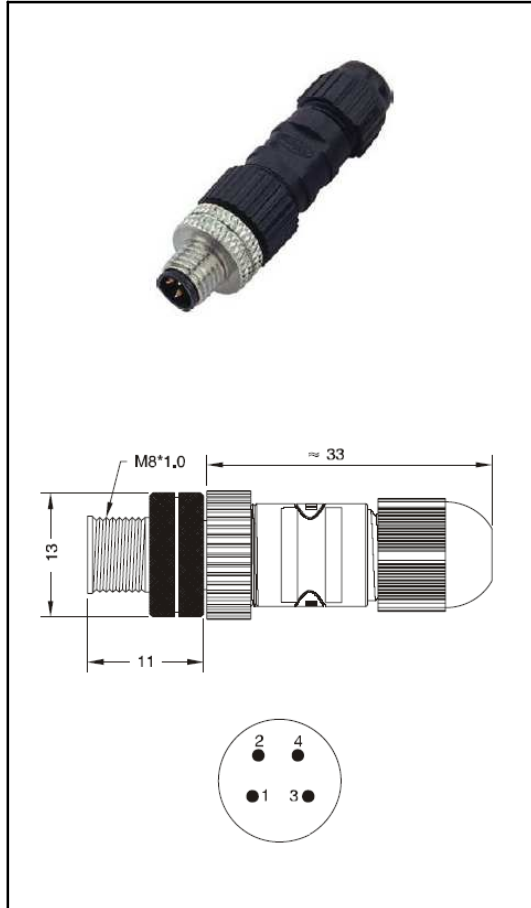

M8 Connectors

Connector Plug M8



Application

Connector for instrumentation and RTD circuits upto 4 wires.

Construction

- Glass filled thermoplastic body with 4 gold plated brass contacts (no thermocouple/compensation material available).
- Construction of pin assignment ensure proper connection.
- IP-67 Protection degree, only in locked position with it's proper counterparts.
- M8 Self locking threaded joint, nickel plated brass
- Terminals for soldering

Wire size

- Accepts wires up to 0,34 mm².
- Cable diameter 3-5 mm.
- Cable gland PG7

Temperature rating

- -25°C up to 90°C

Color Code

- Black.

Standard:

- IEC 61076-2-101.

Ordering Code: **PM8-4-SSOL**